

ENT INSTRUMENTS CATALOG



Dental | Beauty | Veterinary



 VOLGO CARE

Middle Ear Instruments

Ironside Instruments

160mm long, black finish

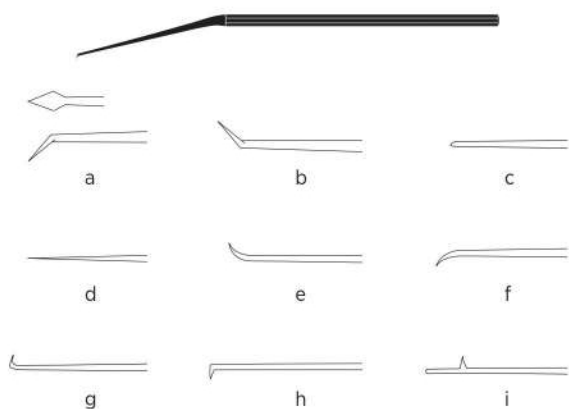

Code	Description
SC-ENT/200a	Knife 1, vertical incision
SC-ENT/200b	Knife 2, horizontal incision
SC-ENT/200c	Elevator
SC-ENT/200d	Needle point
SC-ENT/200e	Hook, superior elevation, angle 45°
SC-ENT/200f	Hook, inferior elevation, angle 45°
SC-ENT/200g	Hook, anterior elevation, angle 90° right
SC-ENT/200h	Hook, anterior elevation, angle 90° left
SC-ENT/200i	Measuring device

Rosen Instruments

160mm long, black finish

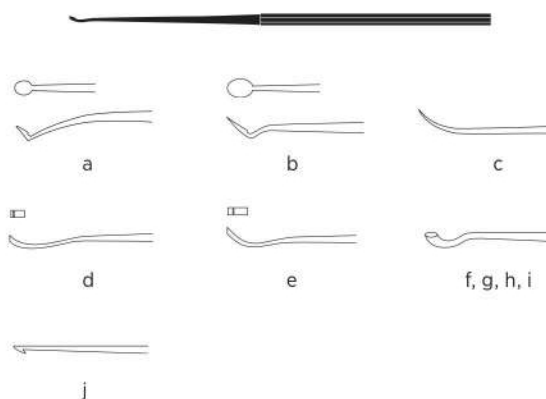

Code	Description
SC-ENT/202a	Curette, tympanic ring, small
SC-ENT/202b	Curette, tympanic ring, large
SC-ENT/202c	Probe, footplate movement test, fine
SC-ENT/202d	Mobiliser, slight curve
SC-ENT/202e	Mobiliser, full curve
SC-ENT/202f	Scoop, size 000
SC-ENT/202g	Scoop, size 00
SC-ENT/202h	Scoop, size 0
SC-ENT/202i	Scoop, size 1
SC-ENT/202j	Fenestrator, oval window

Schuknecht Instruments

160mm long, black finish

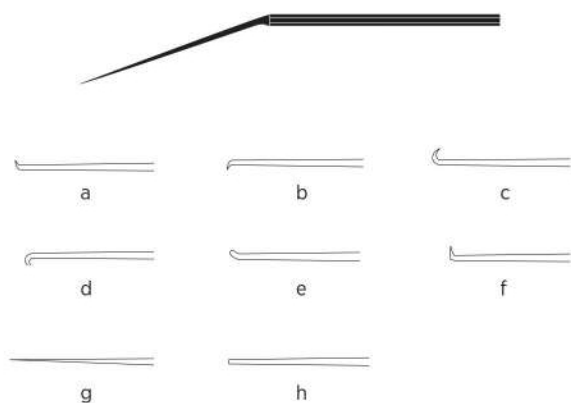

Code	Description
SC-ENT/201a	Hook upward, 0.4mm
SC-ENT/201b	Hook downward, 0.4mm
SC-ENT/201c	Hook upward, 0.7mm
SC-ENT/201d	Hook downward, 0.7mm
SC-ENT/201e	Elevator, oval
SC-ENT/201f	Hook, right-angled upward
SC-ENT/201g	Pick, straight
SC-ENT/201h	Spatula

Beale Instruments

165mm long, satin finish

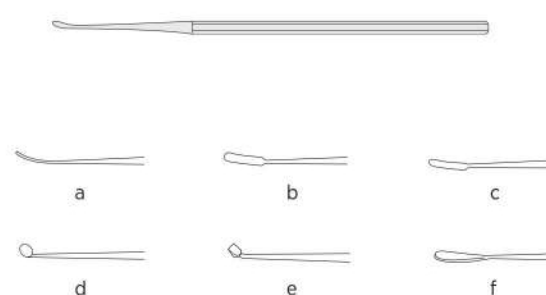

Code	Description
SC-ENT/204a	Tympanoplasty probe, fine blunt end
SC-ENT/204b	Raspatory, slight curve
SC-ENT/204c	Raspatory, slight curve, small
SC-ENT/204d	Rugine, double ended, sharp
SC-ENT/204e	Rugine, double ended
SC-ENT/204f	Spatula, graft smoothing

Beale Instruments

170mm long, satin finish

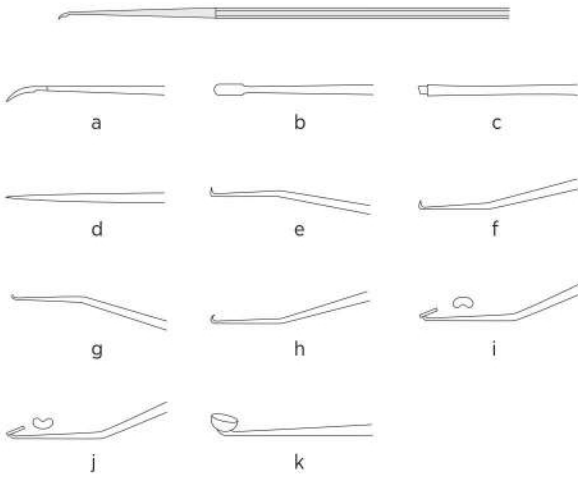

Code	Description
SC-ENT/203a	Knife, Stapedius tendon cutting
SC-ENT/203b	Raspatory, mucous removal
SC-ENT/203c	Osteotome, footplate
SC-ENT/203d	Perforator, elevation fixed footplate
SC-ENT/203e	Hook, removal of footplate, angled downward
SC-ENT/203f	Hook, removal of footplate, angled upward
SC-ENT/203g	Hook, bone removal from oval window, angled left
SC-ENT/203h	Applicator, vein graft for right ear
SC-ENT/203i	Applicator, vein graft for left ear
SC-ENT/203j	Curette, removal bony rim
SC-ENT/203k	Curette

Hough Instruments

165mm long, stainless steel

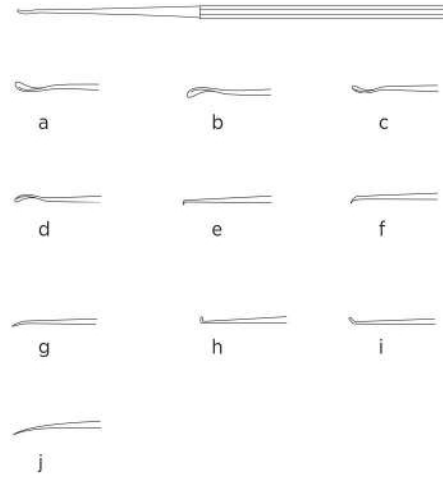

Code	Description
SC-ENT/205a	Excavator, "whirlybird", right, large
SC-ENT/205b	Excavator, "whirlybird", left, large
SC-ENT/205c	Excavator, "whirlybird", right, small
SC-ENT/205d	Excavator, "whirlybird", left, small
SC-ENT/205e	Pick, stapedectomy footplate, angled 90°, 0.33mm
SC-ENT/205f	Pick, stapedectomy footplate, angled 45°, 0.5mm
SC-ENT/205g	Pick, stapedectomy footplate, angled 15°, 0.5mm
SC-ENT/205h	Hook, "hoe", excavator, angled 90°
SC-ENT/205i	Hook, "hoe", excavator, angled 45°
SC-ENT/205j	Pick, curved

Cawthorne Hooks

165mm long, black finish

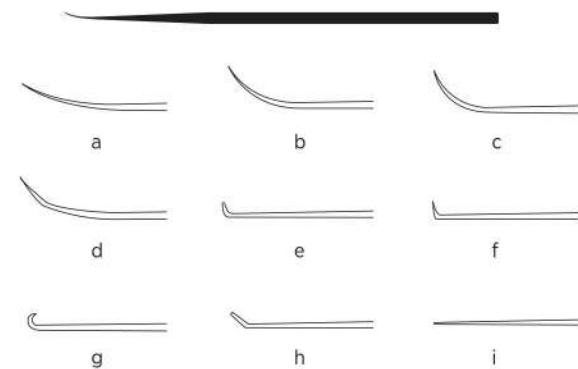

Code	Description
SC-ENT/206a	Slight curve
SC-ENT/206b	Medium curve
SC-ENT/206c	Full curve
SC-ENT/206d	Double curve
SC-ENT/206e	90° angle, 0.5mm
SC-ENT/206f	90° angle, 1.0mm
SC-ENT/206g	45° angle, 0.5mm
SC-ENT/206h	Retrograde
SC-ENT/206i	Straight

Protect your delicate ENT instruments with our custom baskets

Manufactured at our workshop



Contact us with your requirements

info@volgocare.com

Picks and Scoops

Musgrove Cerumen Pick and Wool Carrier

Double ended



Code	Description
SC-ENT/024	178mm long

Formby Cerumen Scoop and Hook

Double ended

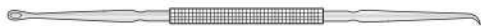

Code	Description
SC-ENT/026	178mm long

Hovell Loop

Fine, for removing hard wax



Code	Description
SC-ENT/027	152mm long

Lempert Scoop

Oval, 200mm long

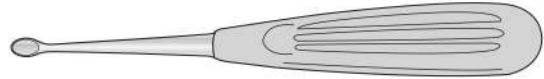

Code	Description
SC-ENT/066a	2mm x 2.5mm
SC-ENT/066b	2mm x 3.5mm
SC-ENT/066c	2mm x 4mm
SC-ENT/066d	2mm x 4.5mm
SC-ENT/066e	3mm x 5.5mm
SC-ENT/066f	3mm x 6mm

House Curette

Double ended, 180mm long



Code	Description
SC-SH/5213	Straight
SC-SH/5213a	Angled

Balance Scoop and Curette



Code	Description
SC-ENT/038	230mm long

Hartmann Hook

Sharp, straight shaft



Code	Description
SC-ENT/021	140mm long

Gardiner Brown Hook and Imray Loop

Double ended



Code	Description
SC-ENT/025	127mm long

Cawthorne Cerumen Hook



Code	Description
SC-ENT/023	143mm long

St Bart's Hook

Blunt, straight handle



Code	Description
SC-ENT/022	178mm long

Tracheal Hook

Sharp



Code	Description
SC-ENT/SH.5672	165mm long

McIndoe Skin Hook

Fine, with flat handle



Code	Description
SC-ENT/057	191mm long

Tracheal Single Hook Retractor

Sharp



Code	Description
SC-GI/SH5671	152mm long

Cawthorne Probe

Silver, flattened end



Code	Description
SC-ENT/019	140mm long

Tracheal Double Hook

Blunt



Code	Description
SC-ENT/SH.5673	105mm long

Jobson Horne Probe

Double ended, serrated tip and smooth ring



Code	Description
SC-ENT/020a	140mm long
SC-ENT/020b	178mm long

Retractors

Mollison Retractor

Self retaining, curved

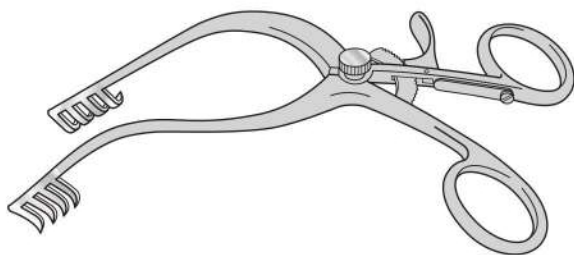

Code	Description
SC-ENT/034a	4-4 teeth, adult, 165mm long
SC-ENT/034b	2-2 teeth, child, 133mm long

Wallace Modified Plester Retractor

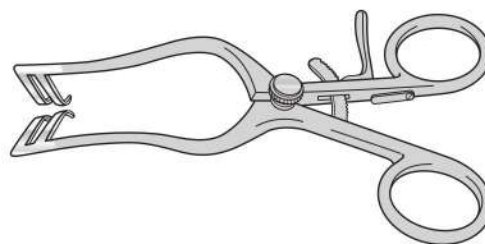

Code	Description
SC-ENT/062	2 x 2 teeth, 140mm long

Plester-Jansen Retractor

Solid blade one side,
140mm long

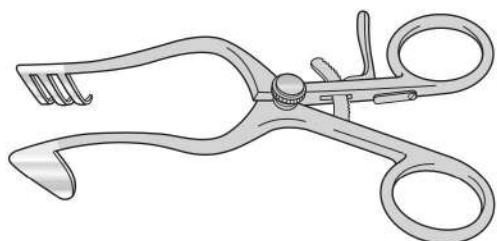

Code	Description
Sc-Ent/061A	Left
Sc-Ent/061B	Right
Sc-Ent/061C	3 x 3 Teeth

Shah Intra Aural Retractor

Satin finish
152mm long

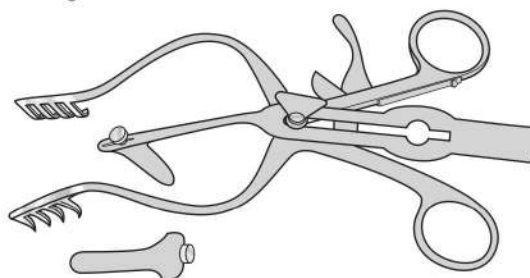

Code	Description
SC-ENT/060a	4-4 teeth, adult, 165mm long
SC-ENT/060b	Third blade
SC-ENT/060c	Intra aural blade
SC-ENT/060d	Post aural blade

Hurd Pillar Retractor and Tonsil Dissector



Code	Description
SC-ENT/147	197mm long

Mollison Anterior Pillar Retractor and Tonsil Enucleator

Semi sharp



Code	Description
SC-ENT/148	210mm long

Ipswich Pattern Sucker



Code	Description
SC-ENT/050a	267mm long

Lempert Suction and Irrigation Tubes

With tucker valve and stilette for cleaning stainless steel, 203mm



Code	Description
SC-ENT/044	6F.G. 2mm
SC-ENT/044a	9F.G. 3mm

Formby Suction Tube

Angled, conical, tip size 10 F.G. stainless steel

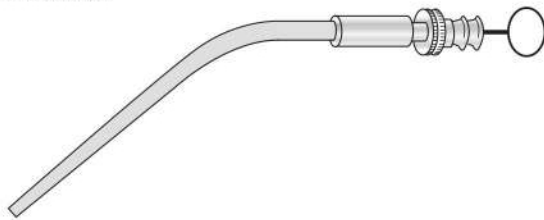

Code	Description
SC-ENT/042	210mm long

Magill Suction Tubes

Set of four with conical ends, one curved, three angled, handle, stainless steel, 210mm



Code	Description
SC-ENT/045	Various sizes
SC-ENT/046a	3.0mm ø
SC-ENT/046b	3.5mm ø
SC-ENT/046c	4.0mm ø

Barron Suction Tube

Small size, 4 F.G. Not for use with Zoellner ends

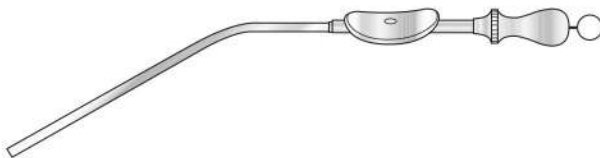

Code	Description
SC-ENT/041	229mm long

Zoellner Suction Tube

With stilette, stainless steel



Code	Description
SC-ENT/047	170mm long, 2mm ø

House Suction and Irrigation Tubes

Stainless steel, 152mm long



Code	Description
SC-ENT/043	8 F.G. x 6 F.G.
SC-ENT/043a	10 F.G. x 7 F.G.
SC-ENT/043b	12 F.G. x 8 F.G.

Rowbotham Suction Tube

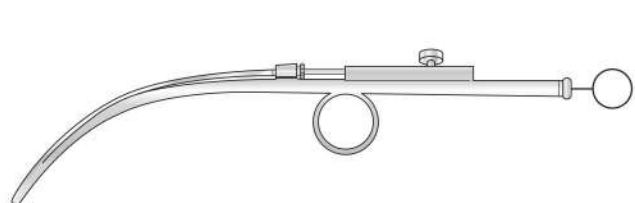

Code	Description
SC-ENT/169	286mm long

Speculum

Rosen Slotted Speculum

Set of four, round ends, black finish
38mm long

Code	Description
SC-ENT/049j	Set of 4
SC-ENT/049f	4mm
SC-ENT/049g	5mm
SC-ENT/049h	6mm
SC-ENT/049i	7mm



Tumarkin Speculum

Set of eight, tapered slot, black finish
50mm long

Code	Description
SC-ENT/052	Set of 8
SC-ENT/053a	4.5mm ø
SC-ENT/053b	6.5mm ø
SC-ENT/053c	7.0mm ø
SC-ENT/053d	7.5mm ø
SC-ENT/053e	8.0mm ø
SC-ENT/053f	8.5mm ø
SC-ENT/053g	9.0mm ø
SC-ENT/053h	11.0mm ø



Rosen Aural Speculum

Round, 40mm long

Code	Description
SC-ENT/049a	3mm
SC-ENT/049b	4mm
SC-ENT/049c	5mm
SC-ENT/049d	6mm
SC-ENT/049e	7mm



Heath Speculum

Set of four, black finish
50mm long

Code	Description
SC-ENT/207e	Set of 4
SC-ENT/207a	4.0mm ø
SC-ENT/207b	5.0mm ø
SC-ENT/207c	6.0mm ø
SC-ENT/207d	7.0mm ø



Shea Speculum

Set of five, oblique ends, black finish, 38mm long

Code	Description
SC-ENT/050	Set of 5
SC-ENT/051	3mm
SC-ENT/051a	4mm
SC-ENT/051b	5mm
SC-ENT/051c	6mm
SC-ENT/051d	7mm



Peters Seigle Speculum



Code	Description
SC-ENT/366	Peters ear speculum black chrome finish set of 5, sizes 0 to 4
SC-ENT/189i	2.2mm x 3.2mm
SC-ENT/189j	2.8mm x 4.2mm
SC-ENT/189k	4.3mm x 5.8mm
SC-ENT/189l	5.2mm x 7.6mm
SC-ENT/189m	6.0mm x 7.6mm
SC-ENT/189d	6mm
SC-ENT/189e	7mm
SC-ENT/189f	8mm
SC-ENT/189g	9mm
SC-ENT/189h	10mm

St Clair Thompson Nasal Speculum

Code	Description
SC-ENT/072	38mm long
SC-ENT/072a	51mm long
SC-ENT/072b	64mm long
SC-ENT/072c	89mm long



Killian Nasal Speculum

With Stop

Code	Description
SC-ENT/081a	51mm blade
SC-ENT/081b	64mm blade
SC-ENT/081c	76mm blade
SC-ENT/081d	89mm blade



Without Stop

Code	Description
SC-ENT/082b	76mm blade

Thudichum Nasal Speculum

Set of seven, sizes 1-7,
70mm long

Code	Description
SC-ENT/073a	Standard
SC-ENT/073b	Insulated

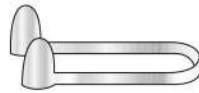

Standard

Code	Description
SC-ENT/073a	Size 1 - 12mm blade
SC-ENT/073a	Size 2 - 14mm blade
SC-ENT/073a	Size 3 - 16mm blade
SC-ENT/073a	Size 4 - 18mm blade
SC-ENT/073a	Size 5 - 20mm blade
SC-ENT/073a	Size 6 - 22mm blade
SC-ENT/073a	Size 7 - 24mm blade
SC-ENT/073a	Size 8 - 27mm blade

Insulated

Code	Description
SC-ENT/073b	Size 1 - 12mm blade
SC-ENT/073b	Size 2 - 14mm blade
SC-ENT/073b	Size 3 - 16mm blade
SC-ENT/073b	Size 4 - 18mm blade
SC-ENT/073b	Size 5 - 20mm blade
SC-ENT/073b	Size 6 - 22mm blade
SC-ENT/073b	Size 7 - 24mm blade
SC-ENT/073b	Size 8 - 27mm blade

Lempert Endaural Speculum



Code	Description
SC-ENT/060e	133mm long

Pilcher Nasal Speculum

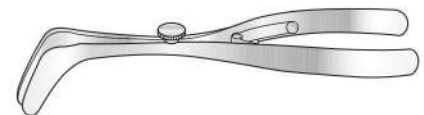

Code	Description
SC-ENT/071	152mm

Cottle Nasal Speculum

127mm long



Code	Description
SC-ENT/192c	20mm blade
SC-ENT/192b	32mm blade
SC-ENT/192	41mm blade
SC-ENT/192a	60mm blade

**Consistent quality across
all our instruments**



Did you know...

Surgical Holdings have patterns and drawings to ensure their instruments are consistent in design and finish for end users.

+
We also
work to British
Standard
BS 5194

Get in touch to discuss your instrument requirements at info@volgocare.com

Aural Forceps



Triangular Jaw

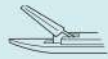

Smooth Jaw



Serrated Jaw



Tenaculum Jaw

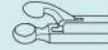

Cup Jaw



Grunwald Punch



Henckel Jaw

Beale Aural Forceps

Micro, black finish, triangular flat jaws, serrated



Code	Description
SC-ENT/183	70mm to shoulder

Hough Aural Forceps

Micro, extra fine oval cup jaws, black finish



Code	Description
SC-ENT/059	70mm to shoulder

Cawthorne Aural Forceps

Micro, black finish, extra fine
70mm to shoulder



Code	Description
SC-ENT/182	Smooth jaws
SC-ENT/199	Serrated jaws

Ormerod Aural Forceps

Micro, extra fine, black finish
70mm to shoulder



Code	Description
SC-ENT/184a	Serrated, angled upwards
SC-ENT/184b	1mm cup jaw
SC-ENT/184c	Elongated cup jaw, 0.5 x 4mm

Hartmann Aural Forceps

Micro, black finish
75mm to shoulder



Code	Description
SC-ENT/058	Serrated jaws
SC-ENT/058a	Tenaculum jaws
SC-ENT/058b	Cup shape jaws
SC-ENT/058c	Curved left, serrated
SC-ENT/058d	Curved right, serrated
SC-ENT/058e	Angled up, serrated
SC-ENT/058f	Serrated jaws, satin finish
SC-ENT/058s	Pre-sterile - single use only

Shea Aural Forceps

Micro, oval cup jaw, black finish
70mm to shoulder



Code	Description
SC-ENT/069	Standard
SC-ENT/069a	Curved to left
SC-ENT/069b	Curved to right
SC-ENT/069c	Curved upward

Hartmann Aural Forceps

Standard, satin finish
75mm to shoulder

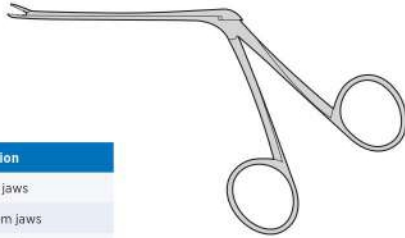

Code	Description
SC-ENT/181	Serrated jaws
SC-ENT/181a	Tenaculum jaws
SC-ENT/181b	Cup shape jaws
SC-ENT/181c	Grunwald punch action

Heath Aural Forceps

Light, with lifting discs, serrated jaws

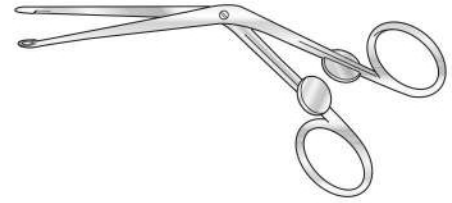

Code	Description
SC-ENT/175	83mm to shoulder

Henckel Aural Forceps

Fine fenestrated scoop blades

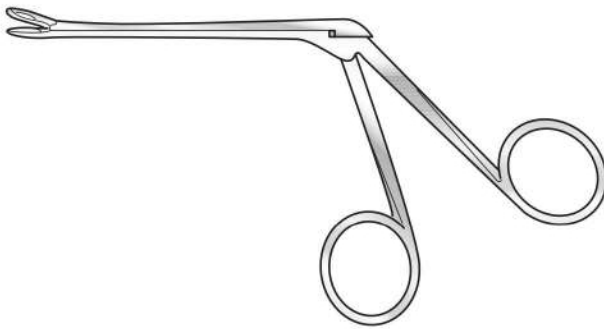

Code	Description
SC-ENT/176	75mm to shoulder

Struycken Cutting Forceps

75mm to shoulder

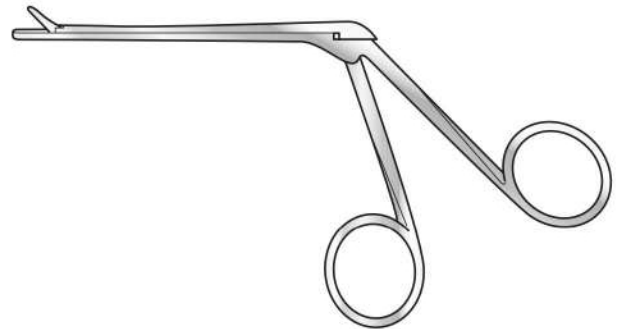

Code	Description
SC-ENT/178	Fenestrated under jaw

Did you know...

We can repair delicate ENT instruments

Our technicians manufacture instruments from scratch, so they have the skills and experience needed to repair even the most delicate instruments.

Get in touch to book a repair
info@volgocare.com

Artery Forceps

Birkett Tonsil Artery Forceps

Fine, 178mm long

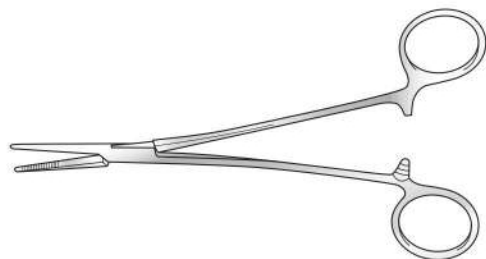

Code	Description
SC-ENT/151a	Straight
SC-ENT/151b	Curved

Negus Tonsil Artery Forceps

180mm long

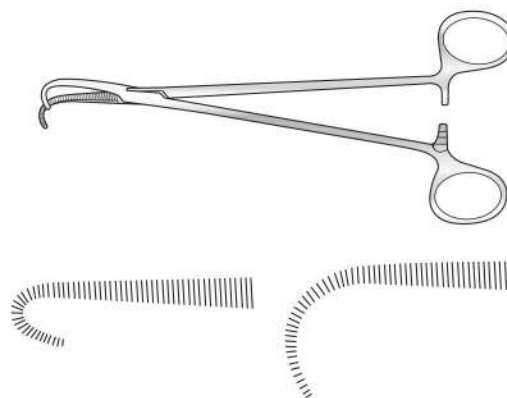

Code	Description
SC-ENT/197	Large curve
SC-ENT/197a	Small curve

Denis Browne Tonsil Artery Forceps

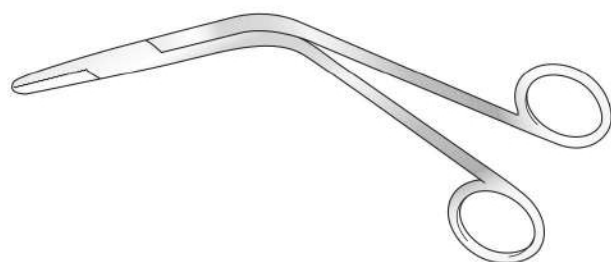

Code	Description
SC-ENT/155	216mm long

Sawtell Tonsil Artery Forceps

178mm long



Code	Description
SC-ENT/152	Large curve
SC-ENT/153	Small curve

Fickling Artery Forceps

190mm long

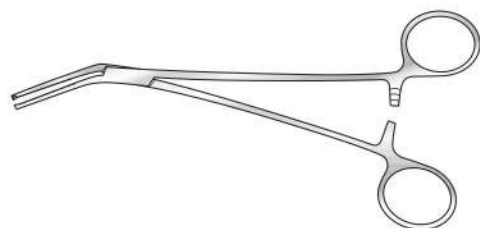

Code	Description
SC-PL/044b	1-2 teeth
SC-PL/044a	Serrated

Scott Tonsil Artery Forceps

Curved to side, screw joint

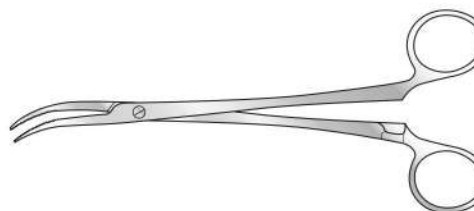

Code	Description
SC-ENT/154	180mm long

Tonsil, Turbinate and Septum Forceps

Denis Browne Tonsil Holding Forceps

Angled shanks, no rack

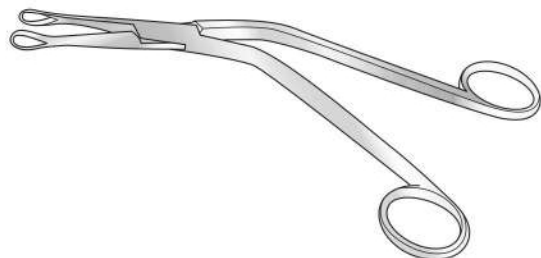

Code	Description
SC-ENT/144	200mm long

Jansen-Middleton Nasal Septum Forceps

Compound action
178mm long

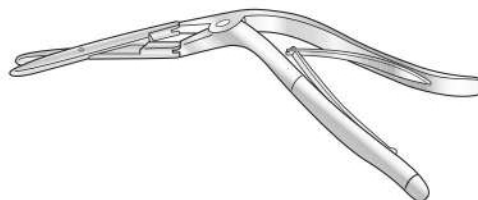

Code	Description
SC-PL/032	5mm jaw

Irwin Moore Nasal Turbinate Forceps

191mm long

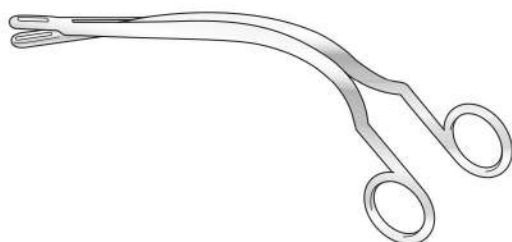

Code	Description
SC-ENT/077d	5mm jaw

Walsham Septum Forceps

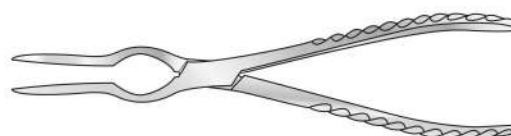

Code	Description
SC-PL/030a	Straight, 215mm long
SC-PL/030b	Right, 215mm long
SC-PL/030c	Left, 215mm long

Luc Nasal Turbinate Forceps

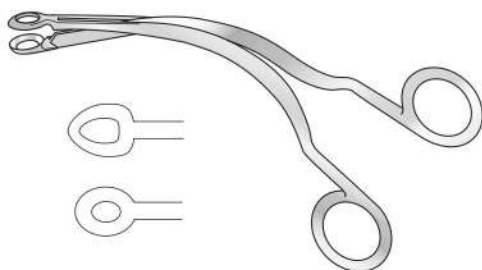

Heart shaped, 178mm long

Code	Description
SC-ENT/078a	Small 6mm ø
SC-ENT/078b	Medium 7.5mm ø
SC-ENT/078c	Large 9.0mm ø

Oval, 191mm long

Code	Description
SC-ENT/078d	Small 6mm ø
SC-ENT/078e	Medium 7.5mm ø
SC-ENT/078f	Large 9.0mm ø

Hartmann Conchotomes

Circular cutting
102mm to shoulder

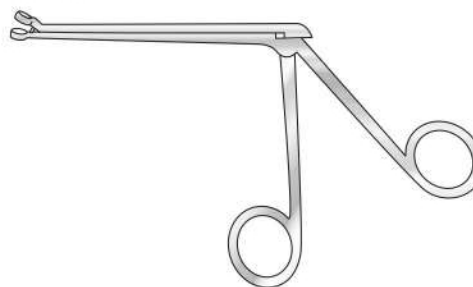

Code	Description
SC-ENT/080a	5mm ø
SC-ENT/080b	7mm ø
SC-ENT/080c	9mm ø
SC-ENT/080d	11mm ø

Dressing Forceps

Hartmann Dressing Forceps

Serrated jaw, screw joint

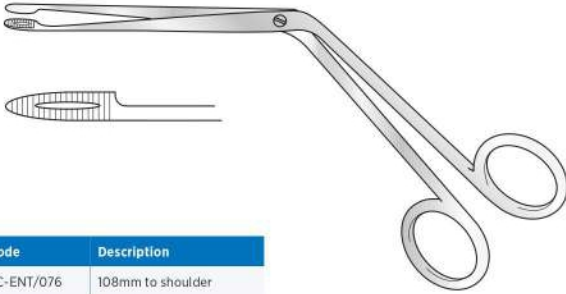

Code	Description
SC-ENT/076	108mm to shoulder

Wilde Dressing Forceps

Angular, serrated jaws

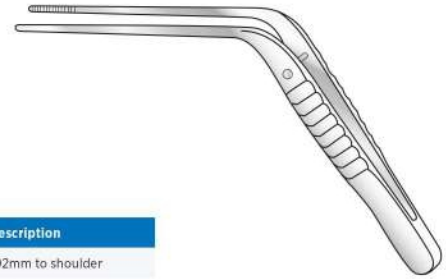

Code	Description
SC-ENT/075	102mm to shoulder

Tilley Dressing Forceps

Straight, fine, serrated ends



Code	Description
SC-ENT/077	2mm wide, 76mm to shoulder

Irwin Moore Thyroid Clamp

Thin jaws, angled to side

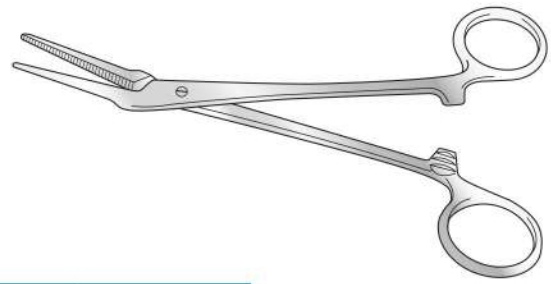

Code	Description
SC-ENT/170	165mm long

Trousseau Tracheal Dilator

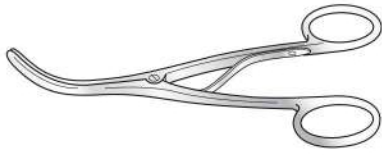

Code	Description
SC-ENT/172	Adult 140mm long
SC-ENT/172a	Child 125mm long

Wilson Bone Nibbling Forceps

Fine, curved, satin finish
152mm long



Code	Description
SC-ENT/054	Downward cutting - 3mm jaws
SC-ENT/055	Upward cutting - 3mm jaws

Cawthorne Nibbling Forceps

Narrow, 3mm jaws, wide handle

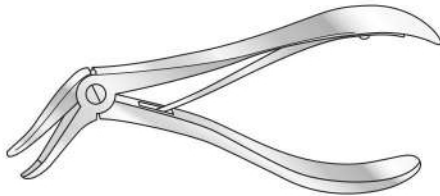

Code	Description
SC-ENT/068	159mm long

Denis Browne Collar Crushing Forceps

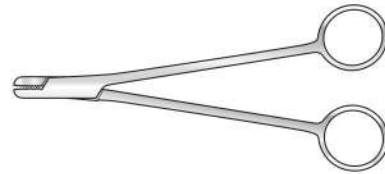

Code	Description
SH-4062	140mm long

Lempert Nibbling Forceps

152mm long



Code	Description
SC-ENT/067a	Straight, 2.5mm jaws
SC-ENT/067b	Angled, 3.0mm jaws

Mouth Gags

Doyen Mouth Gag

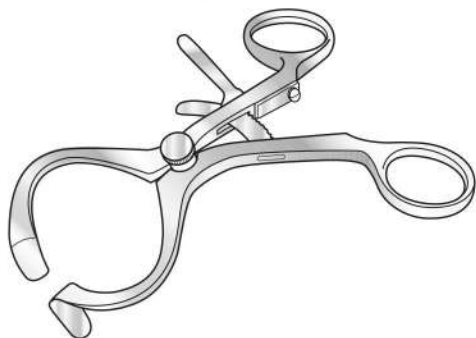

Code	Description
SC-ENT/88d	Adult
SC-ENT/88e	Child

Boyle-Davis Mouth Gag

Frame only

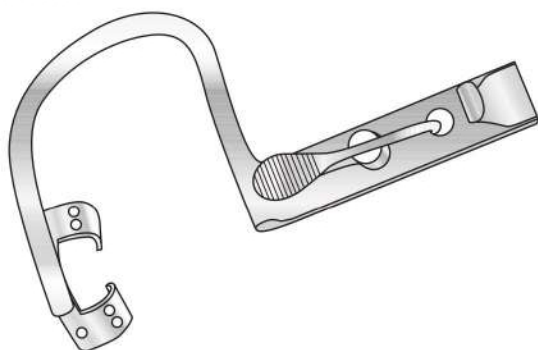

Code	Description
SC-ENT/083a	Adult
SC-ENT/083b	Child

Kilner Dott Mouth Gag

Frame only

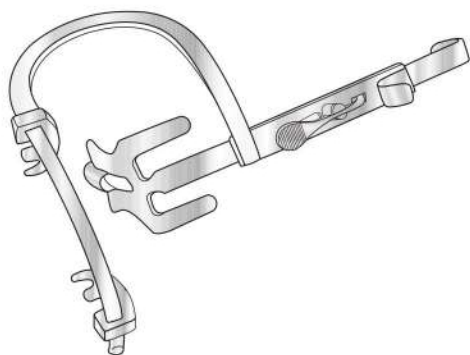

Code	Description
SC-ENT/087a	Adult
SC-ENT/088e	Set, including frame, small, medium, and large blades

Fergusson Ackland Mouth Gag

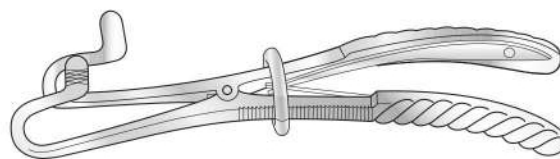

Code	Description
SC-ENT/209	Adult, 210mm
SC-ENT/209a	Child, 155mm

Mason Mouth Gag

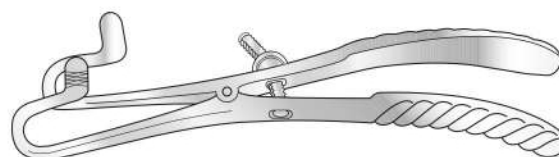

Code	Description
SC-ENT/210	Adult, 210mm

Draffin Bipod



Adult

Code	Description
SC-ENT/083	Adult, 4 hole x 480mm long half circle end for use with a drape
SC-ENT/083E	Adult, 4 hole x 480mm long with round ends to be used with Magauran plate
SC-ENT/083E	Adult, 4 hole x 480mm long with round ends to be used with Magauran plate

Child

Code	Description
SC-ENT/083C	Child, 3 hole x 425mm long half circle end for use with a drape
SC-ENT/083D	Child, 3 hole x 425mm long with round ends to be used with Magauran plate
SC-ENT/083F	Child, 4 hole x 425mm long with round ends to be used with Magauran plate Alder Hey Children's Hospital pattern
SC-ENT/083D	Child, 3 hole x 425mm long with round ends to be used with Magauran plate
SC-ENT/083F	Child, 4 hole x 425mm long with round ends to be used with Magauran plate Alder Hey Children's Hospital pattern
SH-5104	Magauran plate 480mm - for use with Draffin bipods

Magauran Plate

Code	Description
SH-5104	480mm - for use with Draffin bipods

Doughty Tongue Plate

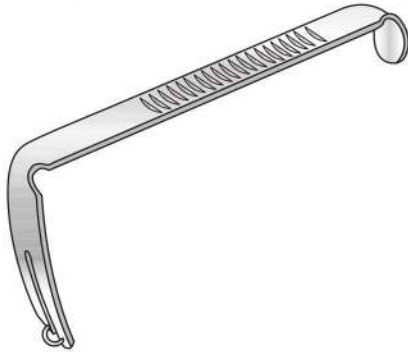

Plain

Code	Description
SC-ENT/084a	65mm - 1.6mm-1.9mm slot
SC-ENT/084b	75mm - 1.6mm-1.9mm slot
SC-ENT/084c	90mm - 4mm-4.5mm slot
SC-ENT/084d	100mm - 4mm-4.5mm slot
SC-ENT/084e	115mm - 4mm-4.5mm slot

Slotted

Code	Description
SC-ENT/085a	65mm - 1.6mm-1.9mm slot
SC-ENT/085b	75mm - 1.6mm-1.9mm slot
SC-ENT/085c	90mm - 4mm-4.5mm slot
SC-ENT/085d	100mm - 4mm-4.5mm slot
SC-ENT/085e	115mm - 4mm-4.5mm slot

With anaesthetic tube

Code	Description
SC-ENT/086a	65mm - 1.6mm-1.9mm slot
SC-ENT/086b	75mm - 1.6mm-1.9mm slot
SC-ENT/086c	90mm - 4mm-4.5mm slot
SC-ENT/086d	100mm - 4mm-4.5mm slot
SC-ENT/086e	115mm - 4mm-4.5mm slot

Tongue Depressor

Flat stainless steel



Code	Description
SC-ENT/143	184mm long

Lack Tongue Depressor

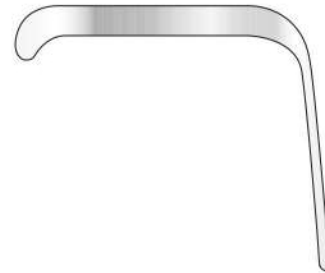

Code	Description
SC-ENT/142a	Child, 13mm wide
SC-ENT/142b	Adolescent, 19mm wide
SC-ENT/142c	Adult, 22mm wide

Kilner Dott Tongue Plate

With endotracheal tube groove

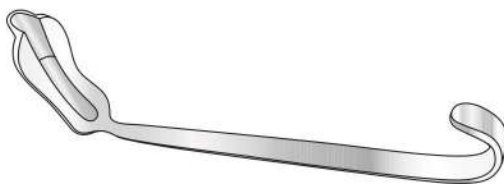

Code	Description
SC-ENT/088a	Small
SC-ENT/088b	Medium
SC-ENT/088c	Large
SC-ENT/088d	Extra small

Punches

Nasal Cutting Forceps



Myles

Through cutting, 120mm to shoulder

Code	Description
SC-ENT/SH5889	12.5 x 3.5mm jaw

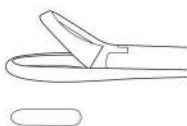

Gruenwald-Henke

Through cutting, 120mm to shoulder

Code	Description
SC-ENT/SH5281	7 x 2mm jaw
SC-ENT/SH5282	9 x 2.5mm jaw

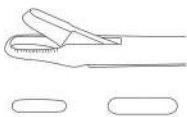

Struycken

Through cutting, 120mm to shoulder

Code	Description
SC-ENT/SH5280	11 x 1mm jaw

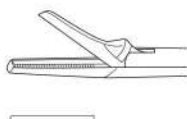

Gruenwald Nasal Punch Forceps

108mm to shoulder

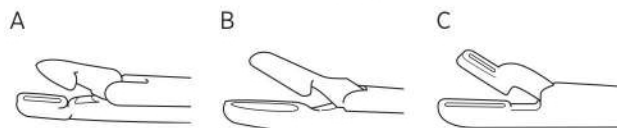
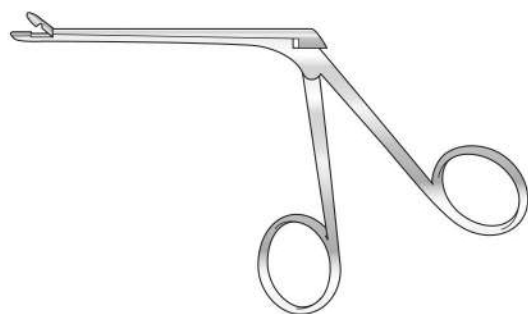

Code	Description
SC-ENT/077a	A fenestrated jaw, 3.5mm
SC-ENT/077b	Fenestrated lower jaw, narrow, 2.5mm
SC-ENT/077c	Fenestrated and tapered lower jaw, 2-3mm

Seymour Jones Antrum Punch Forceps

159mm long

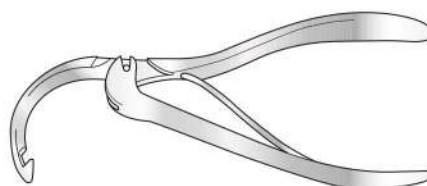

Code	Description
SC-ENT/132	4mm jaw

Backbiter

180mm long

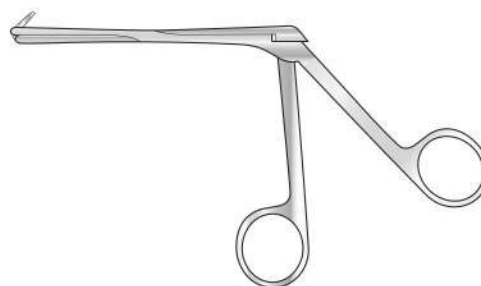

Code	Description
SH/4765b	7 x 3mm jaw

Backbiter

200mm long

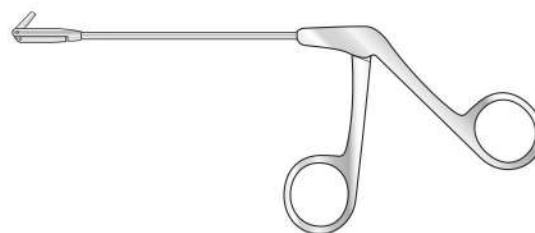

Code	Description
SC-ENT/5392	7 x 2mm jaw

Stamberger Rhinoforcep Antrium Punch

7mm x 3mm, 130mm long

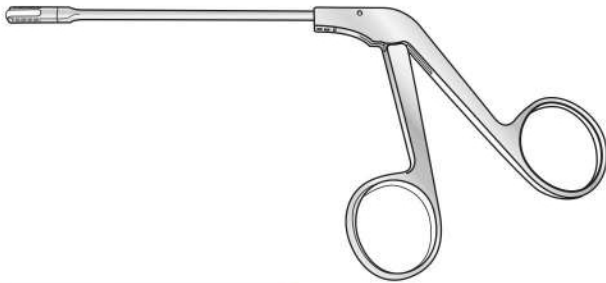

Code	Description
SC-ENT/234	Left back cut
SC-ENT/234a	Right back cut

Tilley Henckel Ethmoid Punch

Graduated shank, 114mm to shoulder

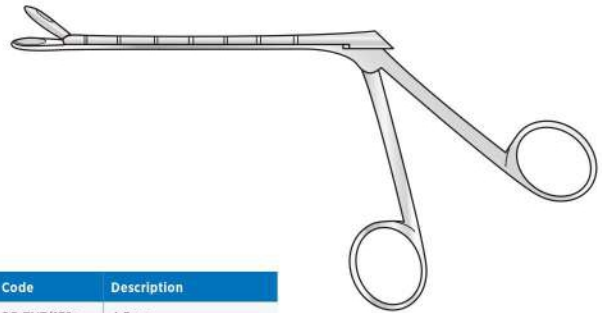

Code	Description
SC-ENT/138a	4.5mm
SC-ENT/138b	5.5mm
SC-ENT/138c	6.5mm
SC-ENT/138d	8mm

Ostrom Antrum Punch

Forcep, 178mm to shoulder

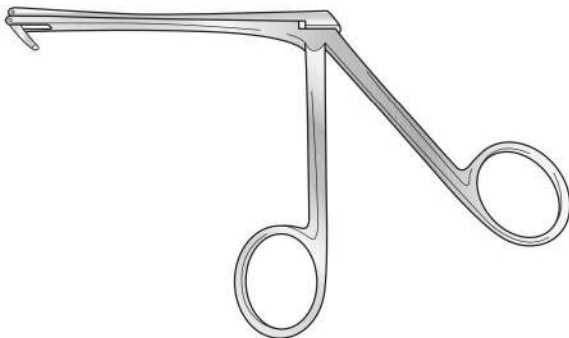

Code	Description
SC-ENT/135	3mm jaw

Mackay Modified Stamberger Punch

200mm long

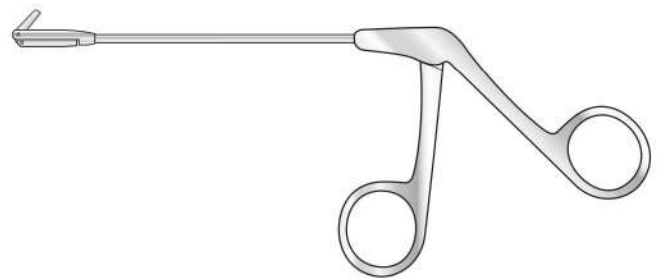

Code	Description
SC-ENT/5392	7 x 2mm jaw

Paterson Biopsy Forceps

Elongated cup, 3mm jaw



Code	Description
SC-ENT/174a	305mm long
SC-ENT/174b	355mm long
SC-ENT/174c	406mm long
SC-ENT/174d	508mm long

Punches

Chevalier Jackson Endoscope Forcep

With crocodile action and serrated jaw

Code	Description
SC-ENT/241	Effective shaft length 300mm
SC-ENT/242	Effective shaft length 400mm
SC-ENT/243	Effective shaft length 500mm
SC-ENT/244	Effective shaft length 600mm

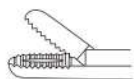

Chevalier Jackson Vocal Nodule Endoscope Forcep

With crocodile action and curved cup

Code	Description
SC-ENT/245	Effective shaft length 300mm
SC-ENT/246	Effective shaft length 400mm
SC-ENT/247	Effective shaft length 500mm
SC-ENT/248	Effective shaft length 600mm

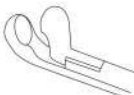

Chevalier Jackson Vocal Nodule Endoscope Forcep

With crocodile action and straight cup

Code	Description
SC-ENT/249	Effective shaft length 300mm
SC-ENT/250	Effective shaft length 400mm
SC-ENT/251	Effective shaft length 500mm
SC-ENT/252	Effective shaft length 600mm



St Bartholomew's Ethmoid Punch

Scoop blades, 3mm bite, 114mm to shoulder

Code	Description
SC-ENT/140a	Straight
SC-ENT/140b	Upward cutting
SC-ENT/140c	Downward cutting

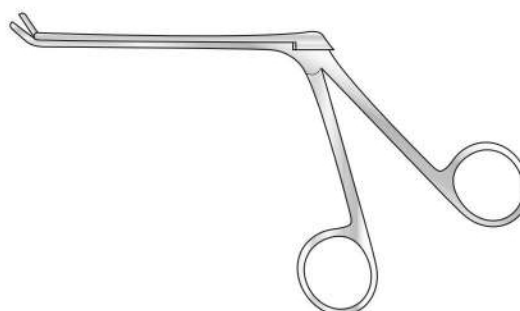

Ferris Smith Kerrison Punch

Heavy, 5mm bite,
229mm long

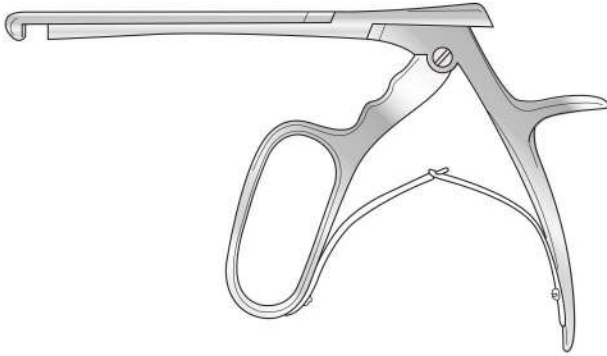

Code	Description
SC-ENT/137a	Upward cutting
SC-ENT/137B	Downward cutting

Citelli Antrum Punch

76mm to shoulder

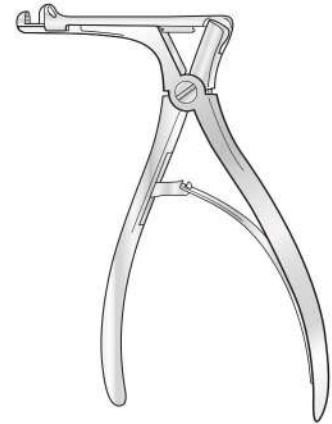

Code	Description
SC-ENT/133a	3mm jaw
SC-ENT/133b	5mm jaw

Hajek Antrum Punch

197mm long

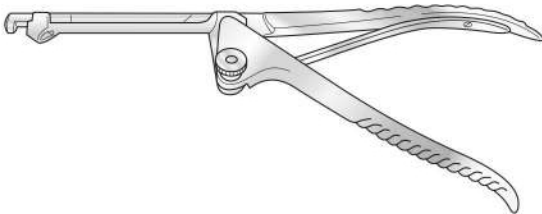

Code	Description
SC-ENT/134	5mm jaw

Hajek Sphenoidal Punch

146mm to shoulder



Upward cutting

Code	Description
SC-ENT/141a	4mm bite
SC-ENT/141b	5mm bite

Downward cutting

Code	Description
SC-ENT/141c	4mm bite
SC-ENT/141d	5mm bite

Rongeurs

Beck Rongeur

Straight, for intervertebral disc

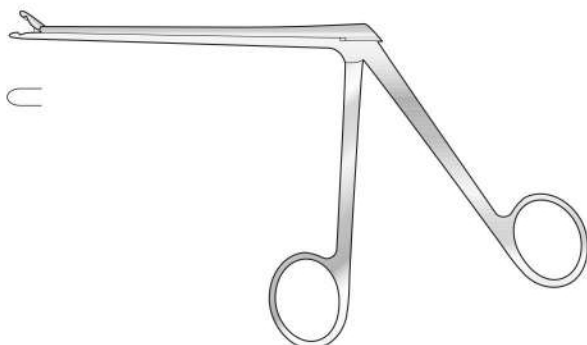

Code	Description
SC-NEU/125	2mm bite, 130mm shaft

Pennybacker Rongeur

120mm shaft

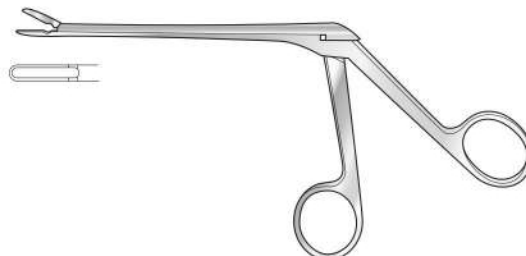

Code	Description
SC-NEU/133	3mm bite
SC-NEU/107	4mm bite

Cushing Rongeur

130mm shaft



Code	Description
SC-NEU/127-2	2mm bite
SC-NEU/127-3	3mm bite
SC-NEU/127-4	4mm bite
SC-NEU/127-5	5mm bite
SC-NEU/127-6	6mm bite



St Bart's Rongeur

114mm shaft

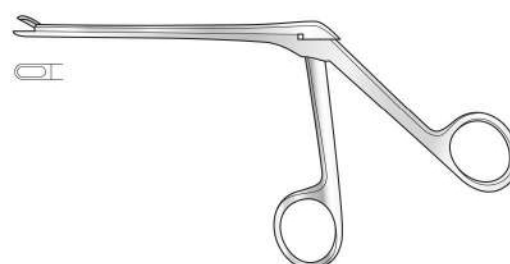

Code	Description
SC-ENT/140a	3mm bite

Cushing Rongeur

130mm shaft



150° upward cutting

Code	Description
SC-NEU/128c	2mm bite
SC-NEU/128	3mm bite
SC-NEU/128a	4mm bite
SC-NEU/128b	5mm bite

150° downward cutting

Code	Description
SC-NEU/130c	2mm bite
SC-NEU/130	3mm bite
SC-NEU/130a	4mm bite
SC-NEU/130b	5mm bite

St Bart's Rongeur

140°, 3mm, 114mm shaft

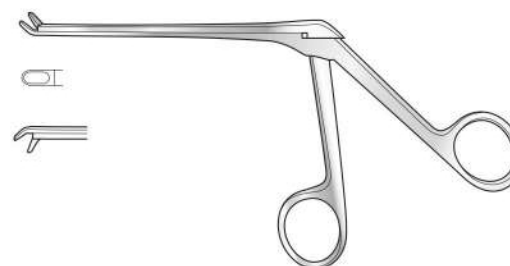

Code	Description
SC-ENT/140b	Upward cutting
SC-ENT/140ac	Downward cutting

Mackay Rongeur

140°, straight, 114mm shaft

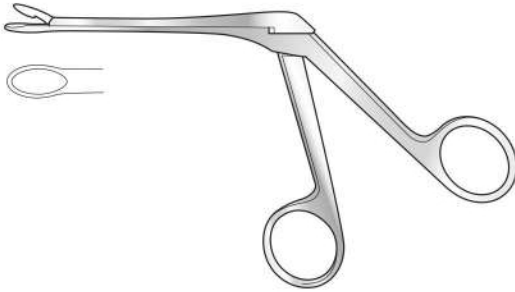

Code	Description
SC-SH/4249	5.5mm

Weil-Blakesley Rongeur

110mm shaft

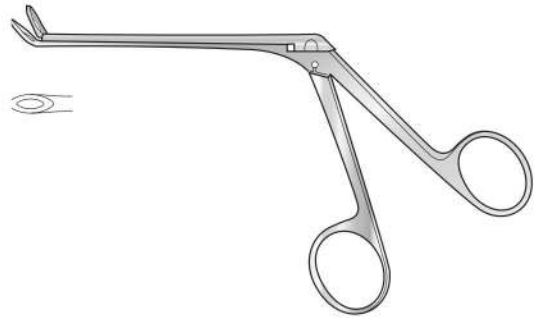

140° upward cutting

Code	Description
SC-ENT/194b	3.6mm bite
SC-ENT/194e	4.2mm bite
SC-ENT/194f	4.8mm bite

140° downward cutting

Code	Description
SC-ENT/194g	3.6mm bite
SC-ENT/194h	4.2mm bite
SC-ENT/194i	4.8mm bite

Mackay Rongeur

With suction tube

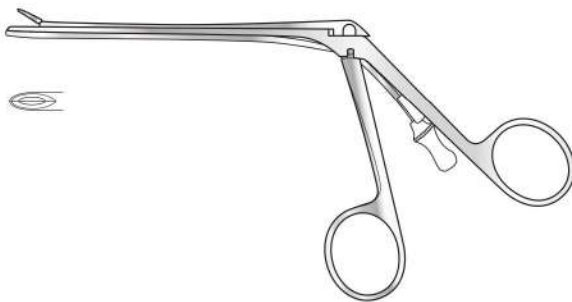

Code	Description
SC-SH/4249a	3.5mm bite, 114mm shaft

Weil-Blakesley Rongeur

120mm shaft



Code	Description
SC-ENT/193b	3.0mm bite
SC-ENT/193	3.6mm bite
SC-ENT/194	4.2mm bite
SC-ENT/194a	4.8mm bite
SC-ENT/194c	5.8mm bite
SC-ENT/194d	6.6mm bite

Mackay Rongeur

With suction tube, 140° upward cutting

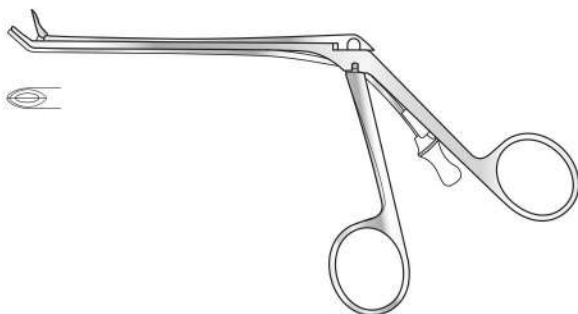

Code	Description
SC-SH/4249b	3.5mm bite, 114mm shaft

Scissors

Beckmann Turbinectomy Scissors

Curved



Code	Description
SC-ENT/097	165mm long

Fomon Scissors

Straight, serrated blades, angled handles

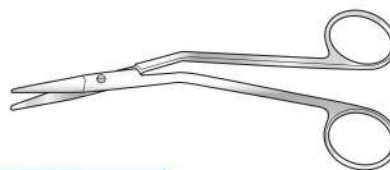

Code	Description
SC-ENT/200	145mm long

Scott Stevenson Tonsil Scissors



Code	Description
SC-ENT/159	216mm long

Cottle Scissors

Straight blades, angled handles, blunt/blunt



Code	Description
SC-ENT/OK201	165mm long

Wood Tonsil Scissors

Sharpened outer edges

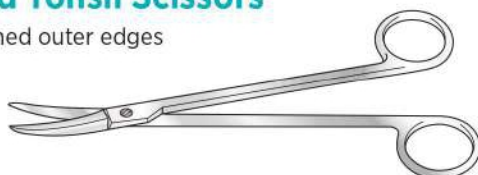

Code	Description
SC-ENT/156	178mm long

Cottle Bulldog Scissors

Blunt/blunt, 115mm long



Code	Description
SC-ENT/202	115mm long

Wheeler Tonsil Scissors

Triangular form blades, serrated shanks

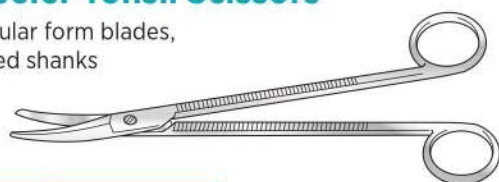

Code	Description
SC-ENT/157	184mm long

Joseph Scissors

Sharp/sharp, 150mm long

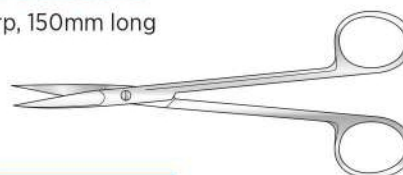

Code	Description
SC-ENT/203	Straight
SC-ENT/204	Curved

Tilley Tonsil Scissors

Curved

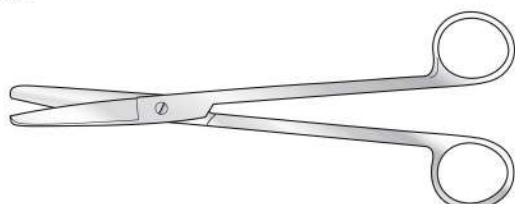

Code	Description
SC-ENT/158	190mm long

Heymann Turbinectomy Scissors

Angular

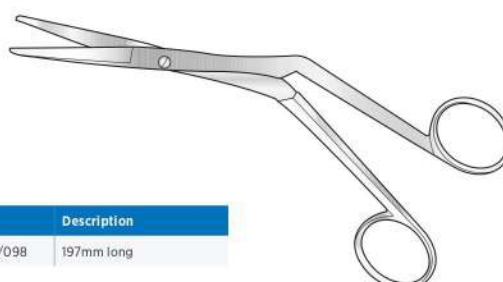

Code	Description
SC-ENT/098	197mm long

Wilson Tonsil Scissors

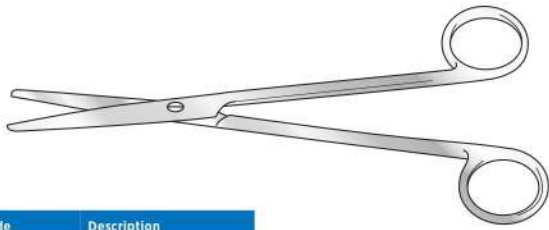

Code	Description
SC-ENT/160	203mm long

Cawthorne Scissors

Micro, extra fine, 70mm to shoulder



Code	Description
SC-ENT/186c	Left
SC-ENT/186d	Right
SC-ENT/186e	Straight

Thyroid Scissors

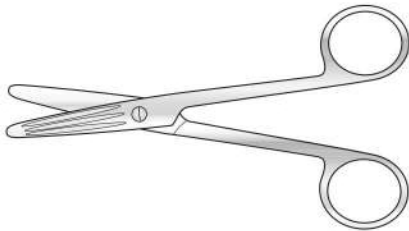

Code	Description
SC-ENT/171	152mm long

Ormorod Aural Scissors

Micro, extra fine, curved upwards



Code	Description
SC-ENT/185	70mm to shoulder

Knapp Scissors

Slight curve, blunt points, 114mm long



Code	Description
SC-ENT/187a	Satin finish
SC-ENT/187b	Black finish

Portmann Aural Scissors

Micro, satin finish
70mm to shoulder

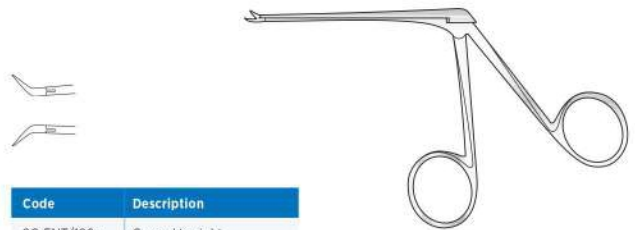

Code	Description
SC-ENT/186a	Curved to right
SC-ENT/186b	Curved to left

Gouges, Knives and Elevators

Ballenger Nasal Cartilage Knife

Revolving blade

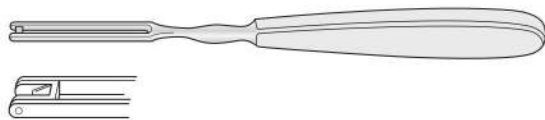

Straight, 203mm long

Code	Description
SC-ENT/096a	6mm wide
SC-ENT/096b	8mm wide

Cranked, 197mm long

Code	Description
SC-ENT/096c	6mm wide

Sickle Knife



Code	Description
SC-BUPNS002	188mm long
SC-ENT/271	160mm long

Jenkins Gouge

140mm long



Code	Description
SC-ENT/037	1mm
SC-ENT/037a	2mm
SC-ENT/037b	3mm
SC-ENT/037c	4mm
SC-ENT/037d	5mm
SC-ENT/037e	6mm
SC-ENT/037f	7mm

Code	Description
SC-ENT/037g	8mm
SC-ENT/037h	9mm
SC-ENT/037i	10mm
SC-ENT/037j	11mm
SC-ENT/037k	12mm
SC-ENT/037l	13mm
SC-ENT/037m	14mm

Killian Nasal Gouge

127mm long



Code	Description
SC-ENT/093	4mm

Guy's Hospital Nasal Gouge

Shallow groove and flattened back, 127mm long



Code	Description
SC-ENT/094	4mm

Tilley Nasal Gouge

V shaped, 127mm long



Code	Description
SC-ENT/095	4mm

Cottle Elevator

Double ended, black chrome finish
200mm long



Code
SC-ENT/224

Hill Elevator

Double ended, curved to side, rugine end



Code	Description
SC-ENT/091	5mm wide, 222mm long

Tumarkin Atticotomy Elevator

Double ended



Code	Description
SC-ENT/036	191mm long

Buck Ear Curette

Angled, blunt, 146mm long

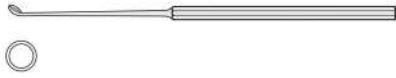

Code	Description
SC-ENT/028	2mm
SC-ENT/028a	2.5mm
SC-ENT/028b	3mm
SC-ENT/028c	3.5mm
SC-ENT/028d	4mm

Nasal Curette

Straight, 185mm long



Code	Description
SC-ENT/628702	5 x 2mm

Beckmann Adenoid Curette

216mm long

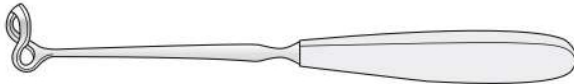

Code	Description
SC-ENT/167a	8mm blade
SC-ENT/167b	10mm blade
SC-ENT/167c	12mm blade
SC-ENT/167d	14mm blade
SC-ENT/167e	16mm blade
SC-ENT/167f	18mm blade

Agnew (Poltzer) Myringotome

190mm long

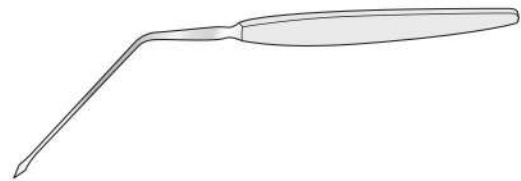

Code	Description
SC-ENT/031	Shaft length 100mm

Trautmann Myringotome

178mm long



Code	Description
SC-ENT/032	Upward cutting
SC-ENT/033	Downward cutting

St Clair Thomson Adenoid Curette

With cage, 235mm long

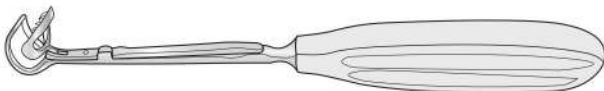

Code	Description
SC-ENT/168a	8mm
SC-ENT/168b	10mm
SC-ENT/168c	12mm
SC-ENT/168d	14mm
SC-ENT/168e	16mm
SC-ENT/168f	18mm

Elevators and Dissectors

Freer Instruments

Single ended, 190mm long

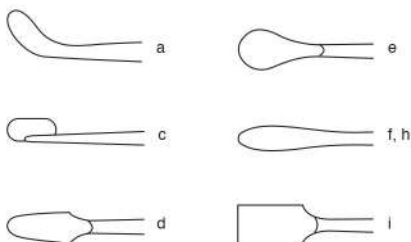

Knife

Code	Description
SC-ENT/065a	Curved to side
SC-ENT/065c	Rounded edge, 8mm blade
SC-ENT/065d	Flat rounded blade
SC-ENT/065e	Rounded blade, curved on flat

Elevator

Code	Description
SC-ENT/065f	Dull edged
SC-ENT/065h	Sharp edged

Chisel

Code
SC-ENT/065i

Freer Separator and Elevator

Double ended

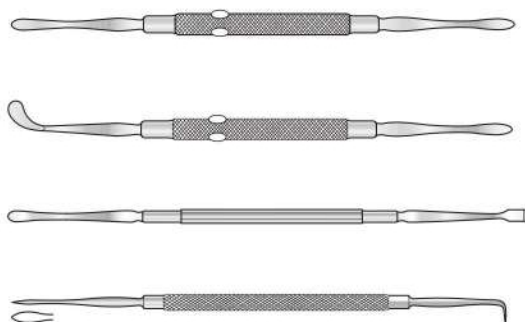

Code	Description
SC-ENT/065b	Blunt/sharp, 180mm long
SC-ENT/065g	Sharp, knife curved to side, 180mm long
SC-ENT/065j	Blunt/sharp, 200mm long
SC-ENT/065j-sal	Blunt/sharp, 188mm long

St Clair Thompson Dissector

159mm



Code	Description
SC-ENT/089a	Sharp
SC-ENT/089b	Blunt

Negus Aspiring Dissector

With 6mm olive, 210mm long



Code	Description
SC-ENT/090a	-
SC-ENT/090b	Insulated

Syme Tonsil Dissector

Double ended, one end blunt, one semi sharp



Code	Description
SC-ENT/149	170mm long

Gwynne-Evans Tonsil Dissector

Double ended, with serrated end and blunt end
197mm long



Code	Description
SC-ENT/146a	6mm wide
SC-ENT/146b	8mm wide

Woakes Eustachian Catheters

Silver, Luer, 140mm



Code	Description
SC-ENT/015	7 F.G.
SC-ENT/015a	8 F.G.
SC-ENT/015b	9 F.G.

Code	Description
SC-ENT/015c	10 F.G.
SC-ENT/015d	11 F.G.

Kramer Eustachian Catheters

Silver, Luer, 140mm



Code	Description
SC-ENT/014	7 F.G.
SC-ENT/014a	8 F.G.
SC-ENT/014b	9 F.G.

Code	Description
SC-ENT/014c	10 F.G.
SC-ENT/014d	11 F.G.

Myles Naso-Antral Perforator

171mm long

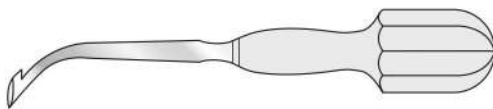

Code	Description
SC-ENT/103a	16 F.G.
SC-ENT/103b	19 F.G.

Tilley Antrum Burrs

171mm long

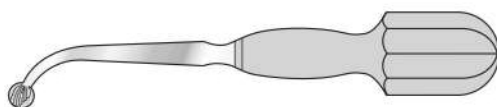

Code	Description
SC-ENT/131a	6mm ø
SC-ENT/131b	7mm ø
SC-ENT/131c	8mm ø

Laryngeal Mirror

Mirror only, 130mm long

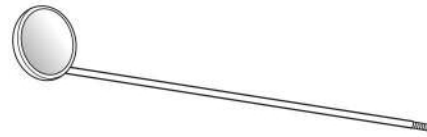

Code	Description
SC-ENT/191-6	6mm ø
SC-ENT/191-8	8mm ø
SC-ENT/191-10	10mm ø
SC-ENT/191-12	12mm ø
SC-ENT/191-14	14mm ø
SC-ENT/191-16	16mm ø
SC-ENT/191-18	18mm ø

Code	Description
SC-ENT/191-20	20mm ø
SC-ENT/191-22	22mm ø
SC-ENT/191-24	24mm ø
SC-ENT/191-26	26mm ø
SC-ENT/191-28	28mm ø
SC-ENT/191-30	30mm ø

Laryngeal Mirror

Complete with metal handle, 260mm long

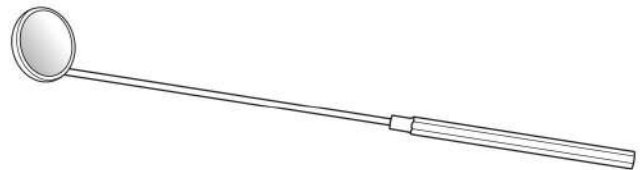

Code	Description
SC-ENT/192-6	6mm ø
SC-ENT/192-8	8mm ø
SC-ENT/192-10	10mm ø
SC-ENT/192-12	12mm ø
SC-ENT/192-14	14mm ø
SC-ENT/192-16	16mm ø
SC-ENT/192-18	18mm ø

Code	Description
SC-ENT/192-20	20mm ø
SC-ENT/192-22	22mm ø
SC-ENT/192-24	24mm ø
SC-ENT/192-26	26mm ø
SC-ENT/192-28	28mm ø
SC-ENT/192-30	30mm ø

Mitchell Trimmer



Code	Description
SC-ENT/013	165mm

Miscellaneous

Lake Seeker

Double ended, for vestibule



Code	Description
SC-ENT/040	184mm long

Negus Pusher

"Knot tier", metal handle



Code	Description
SC-ENT/165	203mm long

Lempert Rugine

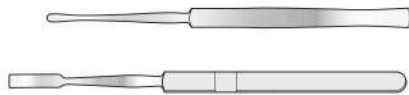

Code	Description
SC-ENT/064a	Narrow, 156mm long
SC-ENT/065a	Broad, 171mm long

Stanford Cade Insufflator

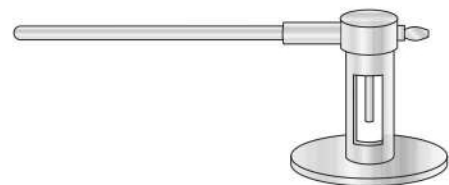

Code	Description
SC-ENT/188	175mm long

Irwin-Moore Tonsil Needle

203mm long



Code	Description
SC-ENT/164a	Curved to right
SC-ENT/164a	Curved to left

Tubing Mount

For use with catheters, Luer



Code	Description
SC-ENT/016	25mm

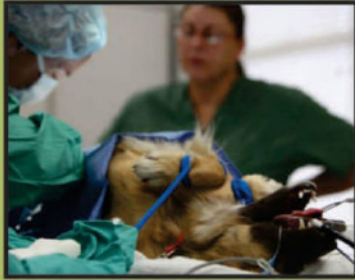

Veterinary



Surgical



Beauty Care

VOLGO CARE INTERNATIONAL

Head Office:

Unit No. 4443, DMCC Business Center
Level No.1, Jewellery & Gemplex 3,
P.O. Box 337614 , Dubai, U.A.E.
Tel:+97144572404
Fax:+97144572403
email: info.ae@volgocare.com

Pakistan Office:

Pacca Garah, Kashmir Road, Sialkot Pakistan
Email: info.pk@volgocare.com

UK Office:

Unit 10 Endeavour House ,2 Cambridge Road
Kingston Upon Thames London , KT1 3JU
email: info.uk@volgocare.com

Spain Office:

Badalona, Barcelona Spain
Email: info.sp@volgocare.com

CERTIFIED:

ISO 9001:2015 / ISO13485:2016 